

# SK 500 G2

Instructions for use

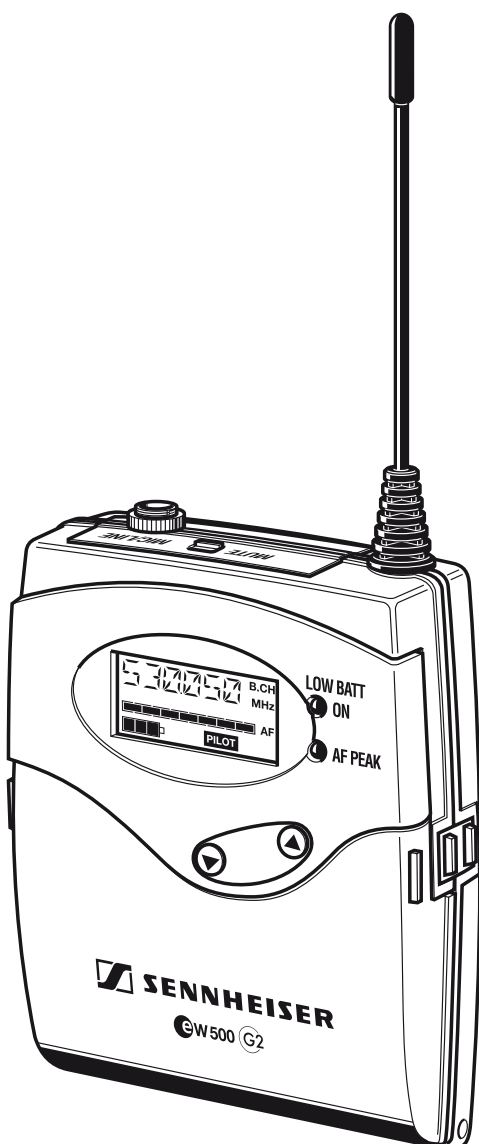



## **Thank you for choosing Sennheiser!**

We have designed this product to give you reliable operation over many years. Over half a century of accumulated expertise in the design and manufacture of high-quality electro-acoustic equipment have made Sennheiser a world-leading company in this field.

Please take a few moments to read these instructions carefully, as we want you to enjoy your new Sennheiser product quickly and to the fullest.

# Contents

The SK 500 G2 bodypack transmitter .....	4
The channel bank system .....	4
Safety instructions .....	5
Delivery includes .....	5
Areas of application .....	6
The operating controls .....	7
Indications and displays .....	8
Preparing the bodypack transmitter for use .....	10
Inserting and replacing the batteries .....	10
Inserting and charging the accupack .....	10
Connecting the microphone/line cable .....	11
Attaching the microphones .....	11
Attaching the transmitter to clothing .....	12
Using the bodypack transmitter .....	13
Switching the transmitter on/off .....	13
Muting the transmitter .....	14
Activating/deactivating the lock mode .....	14
The operating menu .....	15
The buttons .....	15
Overview of menus .....	15
Working with the operating menu .....	16
Operating menu of the transmitter .....	18
Adjustment tips for the operating menu .....	20
Switching between channel banks .....	20
Switching between the channels .....	20
Selecting the frequencies to be stored in the channel bank "U" .....	20
Adjusting the sensitivity .....	21
Selecting the standard display .....	22
Entering a name .....	22
Loading the factory-preset default settings .....	22
Activating/deactivating the pilot tone transmission .....	23
Activating/deactivating the lock mode .....	23
Exiting the operating menu .....	23
Troubleshooting .....	24
Error checklist .....	24
Recommendations and tips .....	25
Care and maintenance .....	26
Specifications .....	27
Connector assignment .....	28
Polar diagrams and frequency response curves of microphones .....	28
Accessories .....	29
Manufacturer declarations .....	30
Warranty regulations .....	30
CE Declaration of Conformity .....	30
Batteries or rechargeable batteries .....	30
WEEE Declaration .....	30

# The SK 500 G2 bodypack transmitter

The SK 500 G2 bodypack transmitter is part of the evolution wireless series ew 500 G2. With this series, Sennheiser offers high-quality state-of-the-art RF transmission systems with a high level of operational reliability and ease of use. Transmitters and receivers permit wireless transmission with studio-quality sound. The excellent transmission reliability of the ew 500 G2 series is based on the use of

- further optimized PLL synthesizer and microprocessor technology,
- the **HDX** noise reduction system,
- and the pilot tone squelch control.

## The channel bank system

The transmitter is available in five UHF frequency ranges with 1440 transmission frequencies per frequency range. Please note: Frequency usage is different for each country. Your Sennheiser agent will have all the necessary details on the available legal frequencies for your area.

Range A: 518 to 554 MHz

Range B: 626 to 662 MHz

Range C: 740 to 776 MHz

Range D: 786 to 822 MHz

Range E: 830 to 866 MHz

The transmitter has nine channel banks with up to 20 switchable channels each.

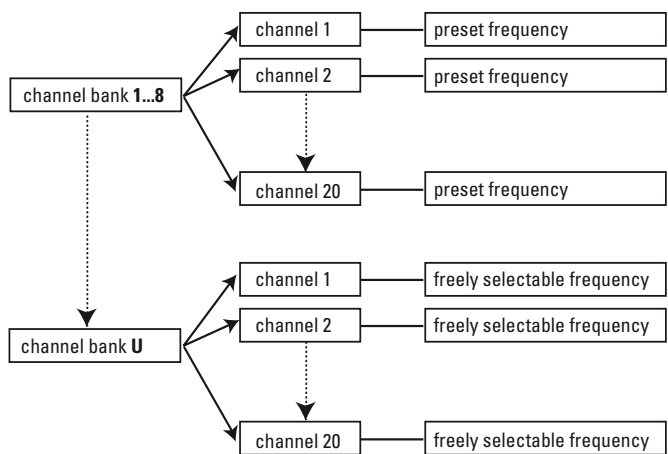

Each of the channels in the channel banks "1" to "8" has been factory-preset to a transmission frequency (see enclosed frequency table). These transmission frequencies cannot be changed but have been preset so that e.g. country-specific regulations on frequency usage are taken into account.

The channel bank "U" (user bank) allows you to store frequencies that are freely selectable.

# Safety instructions

Never open an electronic unit! If units are opened by customers in breach of this instruction, the warranty becomes null and void.

Use the unit in dry rooms only.

Use a damp cloth for cleaning the unit. Do not use any cleansing agents or solvents.

# Delivery includes

The packaging contains the following items:



- 1 SK 500 G2 bodypack transmitter
- 2 batteries
- 1 BPP 1 bodypack pouch
- 1 Instructions for use

# Areas of application

The transmitter can be combined with receivers of the ew 500 G2 series (EM 500 G2 rack-mount receiver or EK 500 G2 bodypack receiver). The receivers are available in the same five UHF frequency ranges and are equipped with the same channel bank system with factory-preset frequencies. An advantage of the factory-preset frequencies is that

- a transmission system is ready for immediate use after switch-on,
- several transmission systems can be operated simultaneously on the preset frequencies without causing intermodulation interference.

Together with a matching receiver and a microphone or an instrument cable, the transmitter is suitable for the following areas of applications:

Transmitter	Receiver (to be ordered separately)	Area of application
SK 500 G2 	EM 500 G2 	<ul style="list-style-type: none"> <li>• Theater</li> <li>• Presentation</li> <li>• Sports (aerobic)</li> <li>• Vocals</li> <li>• Using instruments wirelessly</li> </ul>
	EK 500 G2 	<ul style="list-style-type: none"> <li>• Speech</li> <li>• Vocals</li> <li>• Presentation</li> <li>• Camera-mounted applications</li> </ul>

Four different microphones and an instrument cable are available for the transmitter:

Microphone/ instrument cable	Type	Pick-up pattern	Area of application
ME 2 clip-on microphone	condenser	omni- directional	<ul style="list-style-type: none"> <li>• Theater</li> <li>• Presentation (omni-directional)</li> </ul>
MKE 2-ew clip-on microphone	condenser	omni- directional	professional use: <ul style="list-style-type: none"> <li>• Theater</li> <li>• Presentation</li> </ul>
ME 3 headmic	condenser	super- cardioid	<ul style="list-style-type: none"> <li>• Sports (aerobic)</li> <li>• Vocals</li> </ul>
ME 4 clip-on microphone	condenser	cardioid	<ul style="list-style-type: none"> <li>• Theater</li> <li>• Presentation (high feedback rejection)</li> </ul>
CI 1	instrument cable	–	<ul style="list-style-type: none"> <li>• Using instruments wirelessly</li> </ul>

# The operating controls

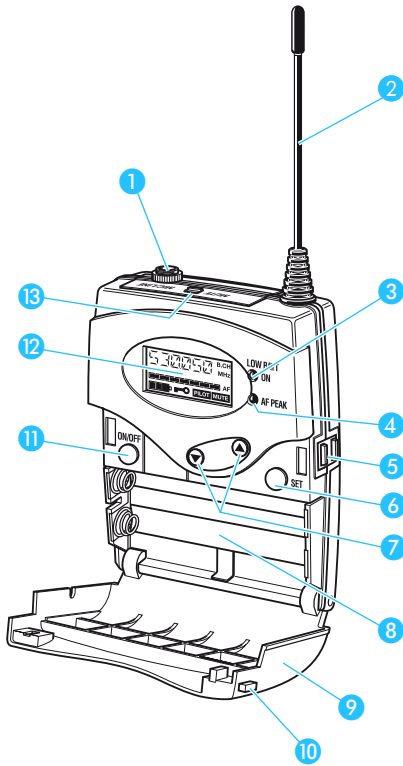

- 1 Microphone/line input (MIC/LINE), 3.5 mm jack socket
- 2 Antenna
- 3 Red LED for operation and battery status indication (ON/LOW BAT)
- 4 Yellow LED for audio peak (AF PEAK)
- 5 Charging contacts
- 6 SET button
- 7 ▼/▲ rocker button (UP/DOWN)
- 8 Battery compartment
- 9 Battery compartment cover
- 10 Unlocking button
- 11 ON/OFF button (serves as the ESC (cancel) key in the operating menu)
- 12 LC display
- 13 MUTE switch

# Indications and displays

## LC display panel

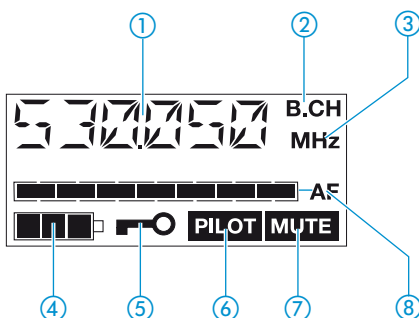

- ① Alphanumeric display
- ② "B.CH" – appears when the channel bank and the channel number are displayed
- ③ "MHz" – appears when the frequency is displayed
- ④ 4-step battery status display
- ⑤ Lock mode icon (lock mode is activated)
- ⑥ "PILOT" display (pilot tone transmission is activated)
- ⑦ "MUTE" display (audio input is muted)
- ⑧ 7-step level display for audio signal "AF"

## Operation and battery status indication

The red LED (LOW BAT/ON) ③ provides information on the current operating state of the transmitter:

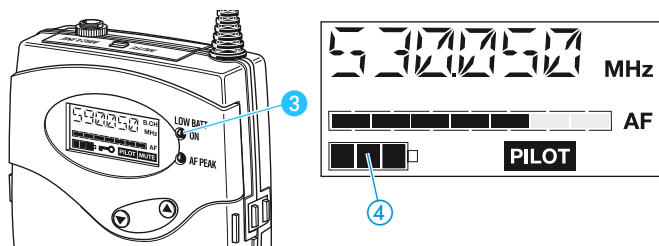

**Red LED lit up:** The transmitter is switched on and the capacity of the batteries/BA 2015 accupack is sufficient.

**Red LED flashing:** The batteries are/the BA 2015 accupack is going flat (LOW BAT)!

In addition, the 4-step battery status display ④ on the display panel provides information on the remaining battery/BA 2015 accupack capacity:

3 segments: capacity approx. 100 %

2 segments: capacity approx. 70 %

1 segment: capacity approx. 30 %

Battery icon flashing: LOW BAT

### “MUTE” display

The “MUTE” display ⑦ appears on the display panel when the transmitter is muted (see “Muting the transmitter” on page 14).

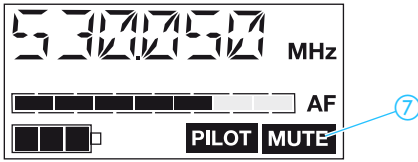

### Modulation display

The level display for audio signal “AF” ⑧ shows the modulation of the transmitter.

When the transmitter’s audio input level is excessively high, the level display for audio signal “AF” ⑧ shows full deflection for the duration of the overmodulation. In addition, the yellow LED (AF PEAK) ④ at the front of the transmitter lights up.

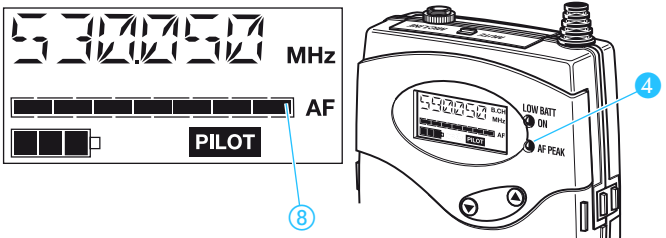

### “PILOT” display

The “PILOT” display ⑥ appears on the display panel when the pilot tone transmission is activated (see “Activating/deactivating the pilot tone transmission” on page 23).

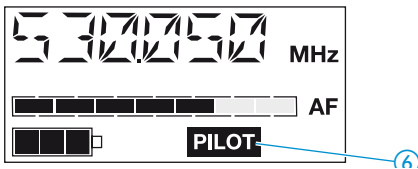

### Display backlighting

After pressing a button, the display remains backlit for approx. 15 seconds.

# Preparing the bodypack transmitter for use

## Inserting and replacing the batteries

For powering the transmitter, two 1.5 V AA size batteries are required.

- ▶ Press the two unlocking buttons 10 and open the battery compartment cover 9.

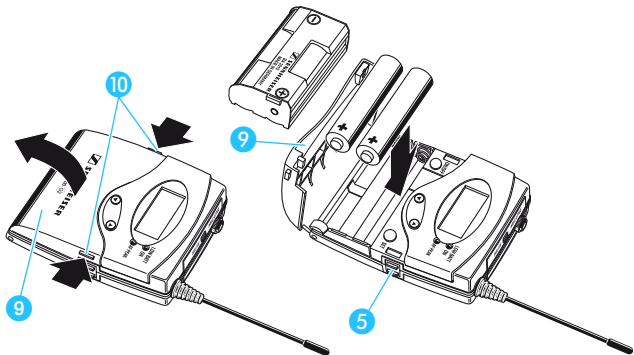

- ▶ Insert the two batteries as shown above. Please observe correct polarity when inserting the batteries.
- ▶ Close the battery compartment. The battery compartment cover 9 locks into place with an audible click.

## Inserting and charging the accupack

The transmitter can also be powered via the rechargeable Sennheiser BA 2015 accupack. Insert the accupack into the battery compartment as described above.

The transmitter has two charging contacts 5 and a sensing contact on its short sides. The accupack can be recharged while remaining in the transmitter. Insert the transmitter into the L 2015 charger (see operating manual of the L 2015 charger).

### Note:

For accupack operation of the transmitter, only use the BA 2015 accupack in order to ensure optimum operational reliability. For charging the accupack, only use the L 2015 charger. Both the accupack and the charger are available as accessories.

The accupack is fitted with an integrated sensor which is – via a third contact – monitored by the electronics of the transmitter and the charger. The sensor is necessary for the following control purposes:

- The taking into account of the different voltage characteristics of primary cells (batteries) and accupacks. The battery status indications on the displays, the transmission of transmitter battery status information to the rack-mount receivers and the switch-off thresholds at the end of the operating time are corrected correspondingly. Due to the missing sensor, individual rechargeable battery cells will not be identified as accupacks.
- The monitoring of the accupack temperature during charging in the L 2015 charger.
- The prevention of improper charging of inserted primary cells (batteries). Due to the missing sensor, individual rechargeable battery cells will also not be charged in the L 2015 charger.

## Connecting the microphone/line cable

The microphone/line input is designed for the connection of both condenser microphones and instruments (e.g. guitars). DC powering of the condenser microphones is via the microphone/line input.

- ▶ Connect the 3.5 mm jack plug **14** from the microphone/line cable to the 3.5 mm jack socket (MIC/LINE) **1**.

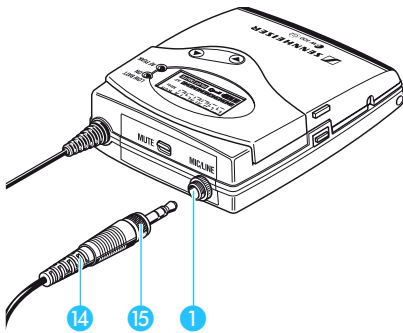

- ▶ Lock the 3.5 mm jack plug by screwing down the coupling ring **15**.
- ▶ Via the operating menu, adjust the sensitivity of the microphone/line input (MIC/LINE) (see "Adjusting the sensitivity" on page 21).

## Attaching the microphones

Use the microphone clips **16** to attach the ME 2 or ME 4 clip-on microphones to clothing (e.g. tie, lapel).

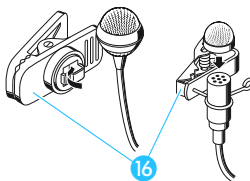

- ▶ Adjust the ME 3 headmic so that a comfortable and secure fit is ensured.

## Positioning the microphones

The ME 3 and ME 4 microphones are directional microphones, i.e. their sound inlet should always be directed towards the sound source (e.g. mouth).

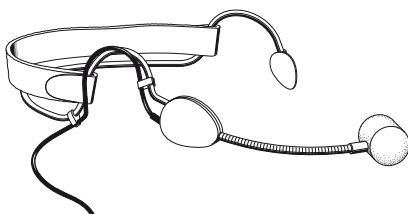

The ME 2 with omni-directional pick-up pattern picks up sound equally from all directions. It is the best choice if movements of the speaker's head have to be compensated for. However, it should be attached as close as possible to the sound source.

Adjust the sensitivity correctly for all microphones/usages (see "Adjusting the sensitivity" on page 21).

## Attaching the transmitter to clothing

The transmitter is attached to clothing (e.g. belt, waistband) with the supplied belt clip.

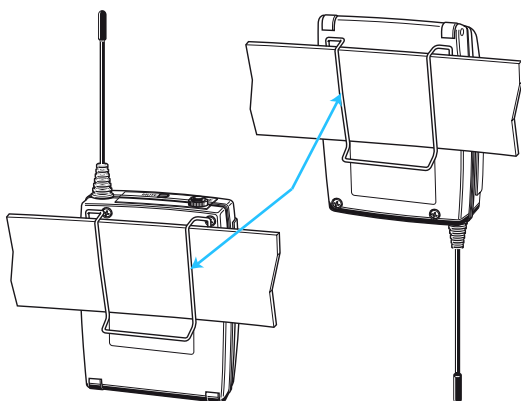

The clip is detachable so that you can also attach the transmitter with the antenna pointing downwards. To do so, withdraw the clip from its fixing points and attach it the other way round.

The supplied BPP 1 bodypack pouch helps to protect the transmitter against moisture.

# Using the bodypack transmitter

## Switching the transmitter on/off

The transmitter can only be switched off when the standard display is shown on the display panel. When in the operating menu, briefly pressing the **ON/OFF** button will cancel your entry (ESC function) and return you to the standard display with the last stored settings.

### Note:

Remove the batteries or the accupack when the transmitter will not be used for extended periods of time.

- ▶ Press the two unlocking buttons **10** and open the battery compartment cover **9**.

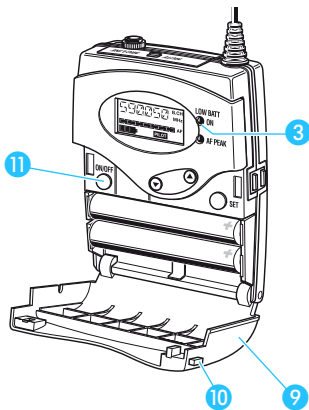

- ▶ Press the **ON/OFF** button **11** to switch the transmitter on. The red LED **3** lights up.
- ▶ To switch the transmitter off, press the **ON/OFF** button **11** until "OFF" appears on the display. The red LED **3** goes off.
- ▶ Close the battery compartment. The battery compartment cover **9** locks into place with an audible click.

## Muting the transmitter

The transmitter has a **MUTE** switch that noiselessly mutes the transmitter's audio signal without switching the transmitter off.

- ▶ Set the **MUTE** switch **12** to the position "MUTE". The "MUTE" display appears on the display panel. Provided that the pilot tone function is activated on both the transmitter and the receiver, the "MUTE" display also appears on the receiver display panel.

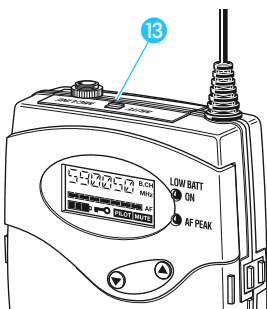

- ▶ Set the **MUTE** switch **13** back to the original position to retransmit the audio signal.

## Activating/deactivating the lock mode

The transmitter has a lock mode that can be activated or deactivated via the operating menu (see "Activating/deactivating the lock mode" on page 23). The lock mode prevents that the transmitter is accidentally programmed or switched off during operation.

# The operating menu

A special feature of the Sennheiser ew 500 G2 series is the similar, intuitive operation of transmitters and receivers. As a result, adjustments to the settings can be made quickly and “without looking” – even in stressful situations, for example on stage or during a live show or presentation.

## The buttons

Buttons	Mode	To...
ON/OFF	Standard display	switch the transmitter on and off
	Operating menu	cancel the entry and return to the standard display
	Setting mode	cancel the entry and return to the standard display
SET	Standard display	get into the operating menu
	Operating menu	get into the setting mode of the selected menu
	Setting mode	store the settings and return to the top menu level
▲/▼	Standard display	without function
	Operating menu	change to the previous menu (▲) or change to the next menu (▼)
	Setting mode	adjust the setting of the selected menu: option (▲/▼)

## Overview of menus

Display	Function of the menu
BANK	Switching between channel banks
CHAN	Switching between the channels in a channel bank
TUNE	Setting a transmission frequency for the channel bank “U” (user bank)
SENSIT	Adjusting the sensitivity (AF)
DISPLY	Selecting the standard display
NAME	Entering a name
RESET	Loading the factory-preset default settings
PILOT	Activating/deactivating the pilot tone transmission
LOCK	Activating/deactivating the lock mode
EXIT	Exiting the operating menu and returning to the standard display

## Working with the operating menu

By way of example of the "TUNE" menu, this section describes how to use the operating menu.

After switching the transmitter on, the standard display is shown on the display panel.

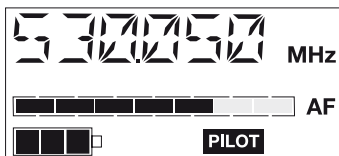

### Getting into the operating menu

- ▶ Press the **SET** button to get from the standard display into the operating menu. The last selected menu flashes on the display.

### Selecting a menu

- ▶ Press the **▲/▼** rocker button to select a menu.



- ▶ Press the **SET** button to get into the setting mode of the selected menu. The current setting that can be adjusted flashes on the display.

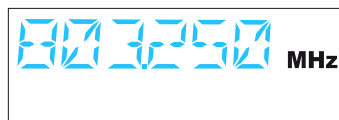

### Adjusting a setting

- ▶ Press the **▲/▼** rocker button to adjust the setting.

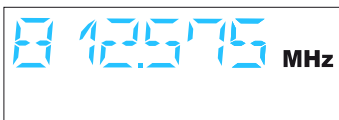

By briefly pressing the **▲/▼** rocker button, the display jumps either forwards or backwards to the next setting. In the "CHAN", "TUNE" and "NAME" menu, the **▲/▼** rocker button features a "fast search" function. If you hold down a button, the display cycles continuously, allowing you to get fast and easily to your desired setting.

### Storing a setting

- ▶ Press the **SET** button to store the setting. "STORED" appears on the display, indicating that the setting has been stored. The display then returns to the top menu level.



With most menus, new settings become effective immediately without having to be stored. An exception are the "BANK", "CHAN", "TUNE" and "RESET" menus. With these menus, new settings only become effective after they have been stored ("STORED" appears on the display, indicating that the setting has been stored).

### Exiting the operating menu

- ▶ Select the "EXIT" menu to exit the operating menu and to return to the standard display.



When in the operating menu, briefly pressing the **ON/OFF** button will cancel your entry (ESC function) and return you to the standard display with the last stored settings.

# Operating menu of the transmitter

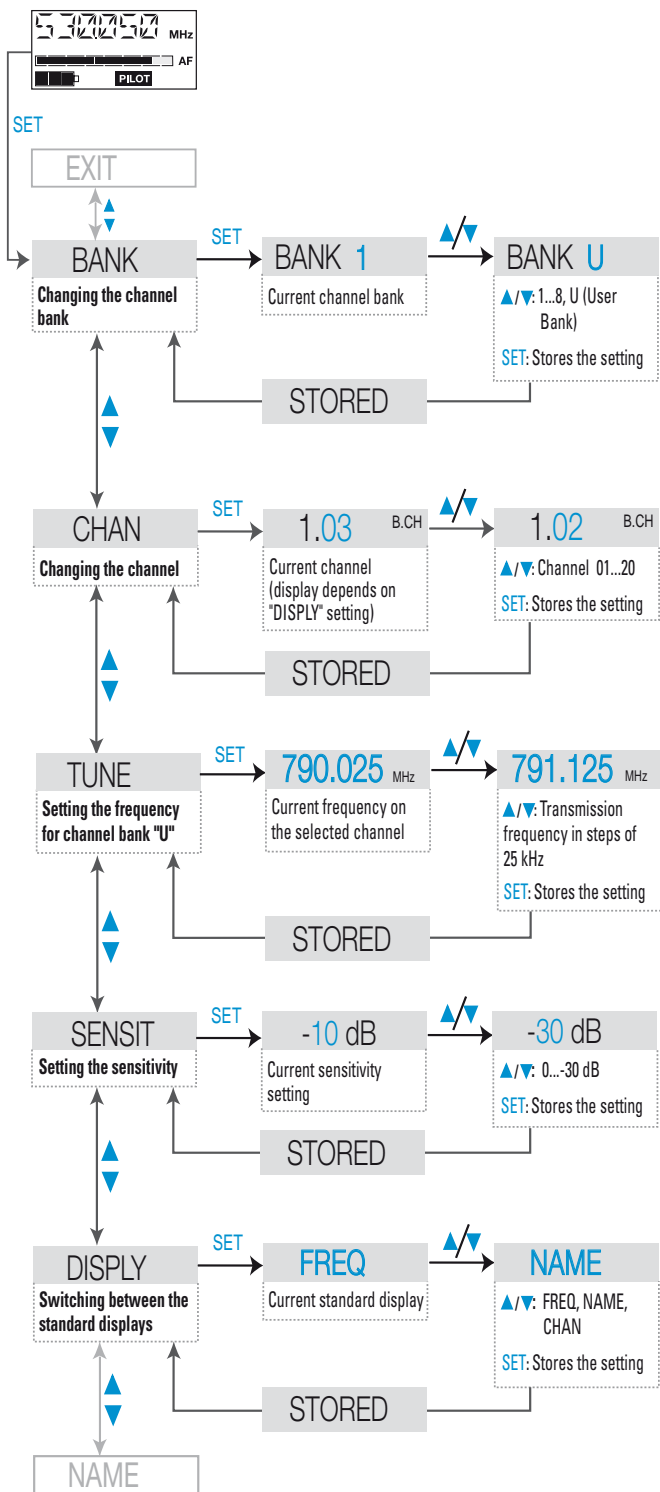

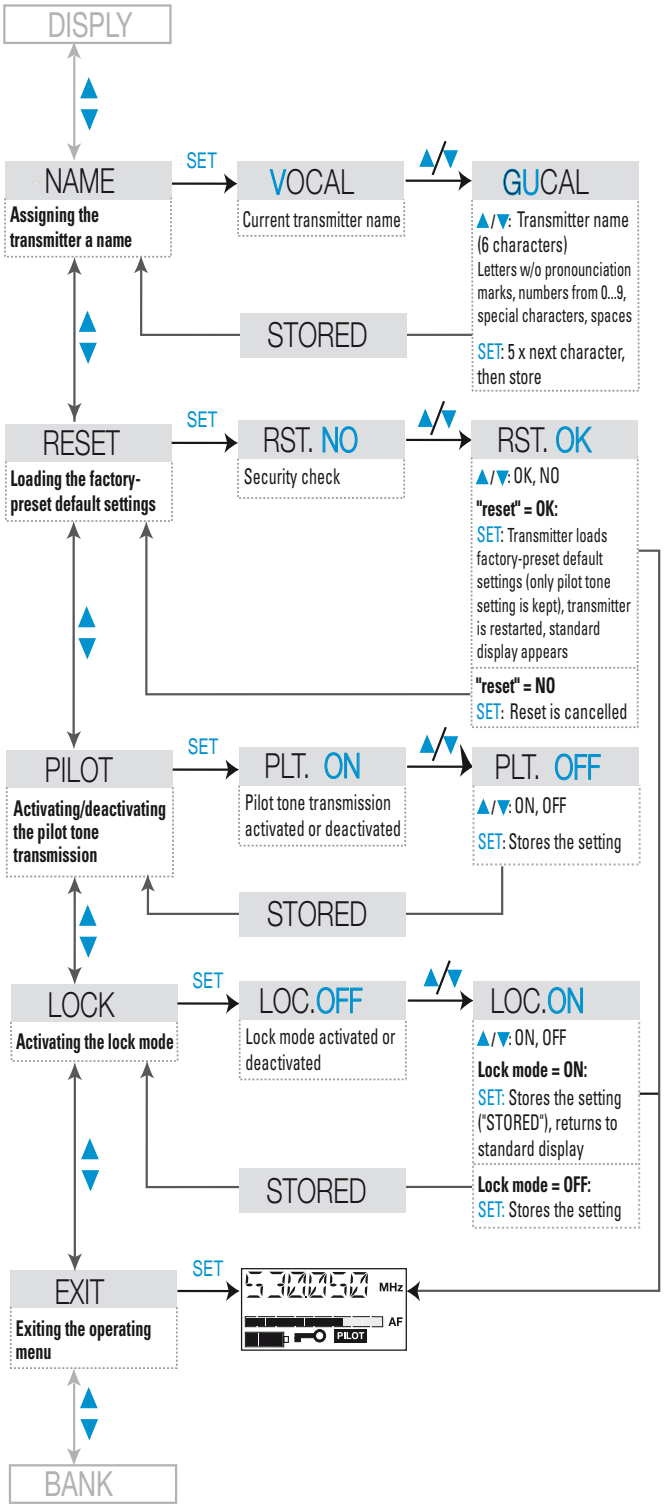

# Adjustment tips for the operating menu

## Switching between channel banks – **BANK**

Via the "**BANK**" menu, you can switch between the transmitter's nine channel banks. Each of the channel banks "1" to "8" has up to 20 switchable channels that are factory-preset to a transmission frequency (see "The channel bank system" on page 4).

The channel bank "U" (user bank) has up to 20 switchable channels to store your selection out of 1440 transmission frequencies that are freely selectable within the preset frequency range.

When switching from one channel bank to another, the channel with the lowest channel number is automatically displayed.

## Switching between the channels – **CHAN**

Via the "**CHAN**" menu, you can switch between the different channels in a channel bank. When switching between the channels, please observe the following:

Always set the transmitter and the receiver of a transmission link to the same channel.

### Multi-channel operation

Combined with ew 500 G2 receivers, the transmitter can form transmission links that can be used in multi-channel systems. For multi-channel operation, only use the free channels in a channel bank.

Before putting the transmission links into operation, we recommend performing an auto scan (see operating manual of the receiver).

## Selecting the frequencies to be stored in the channel bank "U" – **TUNE**

Via the "**TUNE**" menu, you can select the frequencies to be stored in the channel bank "U" (user bank).

When you have selected one of the channel banks "1" to "8" and then select the "**TUNE**" menu, the transmitter automatically switches to channel 01 of the channel bank "U".

In this case, "U.01" briefly appears on the display.



- ▶ Use the ▲/▼ rocker button to select the desired transmission frequency. Transmission frequencies are tunable in 25-kHz steps within a switching bandwidth of 36 MHz max. For intermodulation-free frequencies, please refer to the enclosed frequency table.

## Adjusting the sensitivity – SENSIT

Via the “SENSIT” menu, you can adjust the transmitter’s input sensitivity.

The input sensitivity is adjusted too high when close talking distances, speakers with loud voices or loud music passages cause overmodulation in the transmission link. In this case, the transmitter’s yellow LED (AF PEAK) ④ will light up.

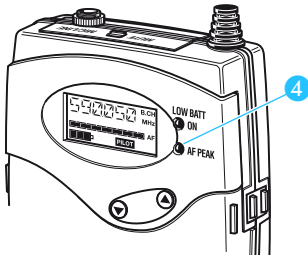

If, on the other hand, the sensitivity is adjusted too low, the transmission link will be undermodulated, which would result in a signal with high background noise.

The sensitivity is correctly adjusted when the level display for audio signal “AF” ⑧ shows full deflection only during the loudest passages.

### Note:



For monitoring the adjusted sensitivity, the transmitter’s level display for audio signal “AF” always indicates the audio level – even if the transmitter is muted.

The following figures are a guide to the best settings:

- Loud music/vocals: -30 to -20 dB
- Presentations: -20 to -10 dB
- Interviews: -10 to 0 dB
- Musical instruments:
  - electric guitars with single coil pickups: -10 bis 0 dB
  - electric guitars with humbucker pickups: -20 to -10 dB
  - guitars with active electronics (active pickups, active EQs, piezo pickups): -30 to -20 dB

## Selecting the standard display – **DISPLPY**

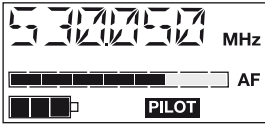
Via the “**DISPLPY**” menu, you can select the standard display:

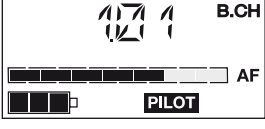
Selectable standard display	Contents of standard display
“ <b>FREQ</b> ”	
“ <b>NAME</b> ”	
“ <b>CHAN</b> ”	

## Entering a name – **NAME**

Via the “**NAME**” menu, you can enter a freely selectable name for the transmitter. You can, for example, enter the name of the performer for whom the adjustments have been made.

The name can be displayed on the standard display and can consist of up to six characters such as:

- letters (without pronunciation marks),
- numbers from 0 to 9,
- special characters e.g. ( ) - . \_ and spaces.

To enter a name, proceed as follows:

- ▶ Press the **SET** button to get into the setting mode of the “**NAME**” menu. The first segment starts flashing on the display.
- ▶ With the ▲/▼ rocker button you can now select a character. By briefly pressing a button, the display jumps either forwards or backwards to the next character. If you hold down a button, the display starts cycling continuously.
- ▶ Press the **SET** button to change to the next segment and select the next character.
- ▶ Have you entered the name completely? Press the **SET** button to store your setting and to return to the top menu level.

## Loading the factory-preset default settings – **RESET**

Via the “**RESET**” menu, you can load the factory-preset default settings. Only the selected setting for the pilot tone

remains unchanged. After the reset, the transmitter is restarted and the standard display is shown on the display panel.

## Activating/deactivating the pilot tone transmission – PILOT

Via the “PILOT” menu, you can activate or deactivate the pilot tone transmission.

The pilot tone supports the receiver’s squelch function (Squelch) and protects against interference due to RF signals from other units. The transmitter adds an inaudible signal, known as the pilot tone, to the transmitted signal. The receiver detects and evaluates the pilot tone.

Transmitters of the ew 500 series (first generation) do not transmit a pilot tone and the receivers of the ew 500 series (first generation) cannot evaluate the pilot tone. Nevertheless, you can combine the transmitter with a receiver of the first generation by observing the following:

- With the ew 500 G2 transmitter and an ew 500 G2 receiver:  
Activate the pilot tone function with both transmitter and receiver.
- With the ew 500 G2 transmitter and an ew 500 receiver or vice versa:  
Deactivate the pilot tone function with the ew 500 G2 transmitter or receiver.

## Activating/deactivating the lock mode – LOCK

Via the “LOCK” menu, you can activate or deactivate the lock mode.

The lock mode prevents that the transmitter is accidentally programmed or switched off during operation. The lock mode icon ⑦ on the display indicates that the lock mode is activated.

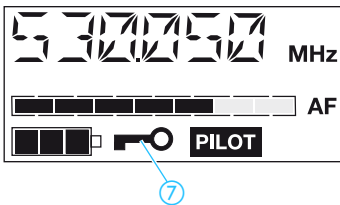

To deactivate the lock mode, first press the SET button and then press the ▲/▼ rocker button to select “LOC.OFF”. If you confirm your selection by pressing the SET button, the buttons can be operated as usual.

## Exiting the operating menu – EXIT

Via the “EXIT” menu, you can exit the operating menu and return to the standard display.

# Troubleshooting

## Error checklist

Problem	Possible cause	Possible solution
No operation indication	Batteries are flat or accupack is flat	Replace the batteries or recharge the accupack
No RF signal	Transmitter and receiver are not on the same channel	Set transmitter and receiver to the same channel
	Transmitter is out of range	Check the squelch threshold setting or reduce the distance between transmitter and receiving antenna
RF signal available, no audio signal, "MUTE" display appears on the display panel	Transmitter is muted ("MUTE")	Deactivate the muting function
	Receiver's squelch threshold is adjusted too high	Reduce the squelch threshold
	Transmitter doesn't transmit a pilot tone	Activate the pilot tone transmission
Audio signal has a high level of background noise	Transmitter sensitivity is adjusted too low	See "Adjusting the sensitivity" on page 21
	Receiver's AF output level is adjusted too low	Increase the audio output level
Audio signal is distorted	Transmitter sensitivity is adjusted too high	See "Adjusting the sensitivity" on page 21
	Receiver's AF output level is adjusted too high	Reduce the AF output level

If problems occur that are not listed in the above table or if the problems cannot be solved with the proposed solutions, please contact your local Sennheiser agent for assistance.

## Recommendations and tips

### ... for the ME 2 and ME 4 clip-on microphones

- To reduce level variations to a minimum when the user turns his or her head away from the microphone, attach the microphone as centrally as possible.
- To protect the microphone against excessive sweat/moisture, avoid direct skin contact.
- Attach the microphone carefully and conduct the cable so that noise due to friction is avoided.
- Always use the ME 4 directional microphone with a windshield and direct the microphone towards the sound source (e.g. mouth).

### ... for the ME 3 headmic

- Always use the microphone with a popshield and position the microphone at the corner of the mouth.
- You can vary the bass reproduction by increasing/decreasing the talking distance.
- Make sure that the sound inlet is directed towards the mouth. The sound inlet is marked with a little dot.

### ... for the bodypack transmitter

- Make sure that the antenna and the microphone cable do not cross.
- The antenna should hang freely and be at least 1 cm away from the body. The antenna must not be in direct contact with the skin.
- For best results, make sure that the transmitter sensitivity is correctly adjusted.

### ... for optimum reception

- Transmission range depends to a large extent on location and can vary from about 10 m to about 150 m. There should be a "free line of sight" between transmitting and receiving antennas.
- To avoid overmodulating the receiver, observe a minimum distance of 5 m between transmitting and receiving antennas.

### ... for multi-channel operation

- For multi-channel operation, you can only use the channels in a channel bank. Each of the channel banks "1" to "8" accommodates up to 20 factory-preset frequencies which are intermodulation-free. For alternative frequency combinations, please refer to the enclosed frequency table. The freely selectable frequencies can be selected via the "TUNE" menu and can be stored in the channel bank "U".
- When using several transmitters simultaneously, interference can be avoided by maintaining a minimum distance of 20 cm between two transmitters.

# Care and maintenance

Use a slightly damp cloth to clean the transmitter from time to time.

**Note:**

Do not use any cleansing agents or solvents.

# Specifications

## RF characteristics

Modulation	wideband FM
Frequency ranges	518–554, 626–662, 740–776, 786–822, 830–866 MHz
Transmission frequencies	8 channel banks with up to 20 factory-preset channels each 1 channel bank with up to 20 freely selectable channels (1440 frequencies, tunable in steps of 25 kHz)
Switching bandwidth	36 MHz
Nominal/peak deviation	$\pm 24$ kHz / $\pm 48$ kHz
Frequency stability	$\leq \pm 15$ ppm
RF output power at 50 $\Omega$	typ. 30 mW

## AF characteristics

Noise reduction system	Sennheiser <a href="#">HDX</a>
AF frequency response	40–18,000 Hz
S/N ratio (at 1 mV and peak deviation)	$\geq 110$ dB(A)
THD (at nominal deviation and 1 kHz)	$\leq 0.9$ %
Max. input voltage (at peak deviation)	
Microphone	1.8 V <sub>rms</sub> , unbalanced
Line	2.9 V <sub>rmsf</sub>
Input impedance	
Microphone	10 k $\Omega$ , unbalanced
Line	1 M $\Omega$

## Overall unit

Temperature range	– 10 °C to + 55 °C
Power supply	2 AA size batteries, 1.5 V or BA 2015 accupack
Nominal voltage	2.4 V
Max. power consumption at nominal voltage	$\leq 170$ mA
Power consumption with switched-off transmitter	$\leq 250$ $\mu$ A
Operating time (with batteries)	$\geq 8$ h
Operating time (with BA 2015 accupack)	$\geq 8$ h
Dimensions [mm]	82 x 64 x 24
Weight (incl. batteries)	approx. 158 g

## Microphones

	ME 2	MKE 2-ew	ME 3	ME 4
Transducer Principle	condenser	condenser	condenser	condenser
Sensitivity	20 mV/Pa	5.6 mV/Pa	1.6 mV/Pa	40 mV/Pa
Pick-up pattern	omni-directional	omni-directional	super-cardioid	cardioid
Max. SPL	130 dB SPL	140 dB SPL	150 dB SPL	120 dB SPL

## Connector assignment

3.5 mm jack plug:

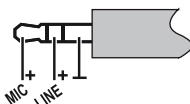

## Polar diagrams and frequency response curves of microphones

Polar diagram  
ME 3

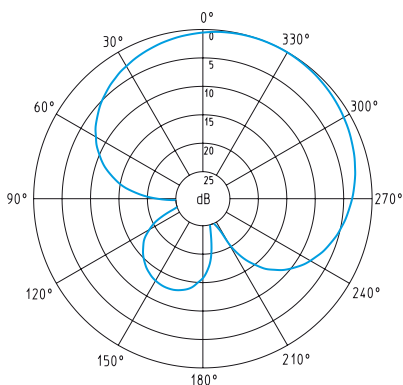

Polar diagram  
ME 4

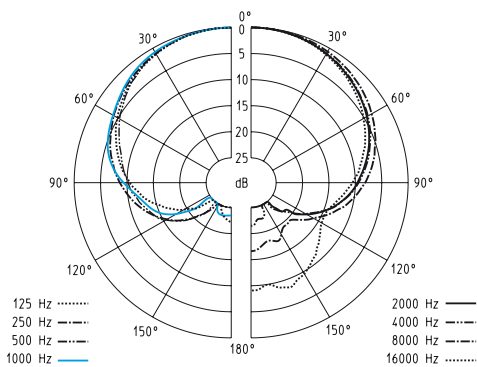

## Frequency response curve ME 2

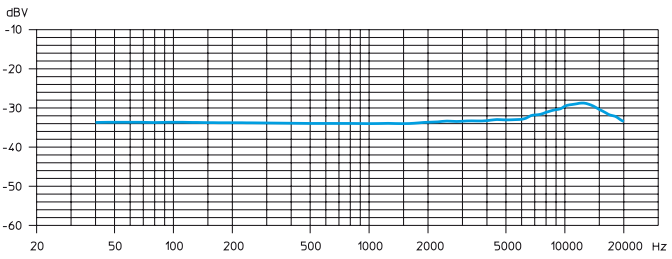

## Frequency response curve ME 3

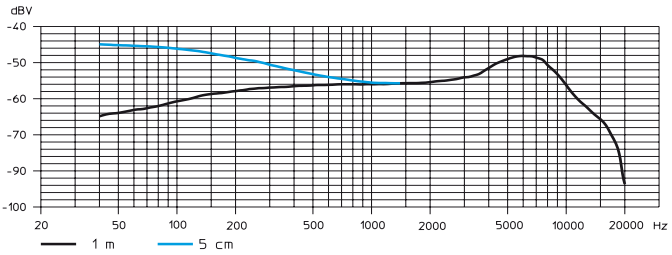

## Frequency response curve ME 4

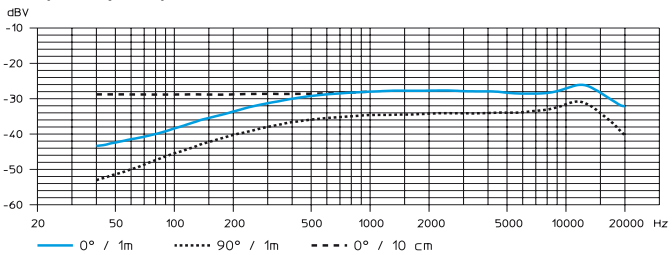

## Accessories

- ME 2:** Clip-on microphone, condenser, omni-directional
- MKE 2:** Clip-on microphone, black or beige, condenser, omni-directional
- ME 4:** Clip-on microphone, condenser, cardioid
- ME 3:** Headmic, condenser, super-cardioid
- CI 1:** Instrument cable, with 1/4" (6.3 mm) jack plug
- CL 2:** Line input cable, with XLR-3F connector
- DC 2:** DC power adapter, for external 12 V DC powering (instead of two AA size batteries)
- BA 2015:** Accupack
- L 2015:** Charger for BA 2015 accupack
- CC 2:** Carrying case

# Manufacturer declarations

## Warranty regulations

The guarantee period for this Sennheiser product is 24 months from the date of purchase. Excluded are accessory items, rechargeable or disposable batteries that are delivered with the product; due to their characteristics these products have a shorter service life that is principally dependent on the individual frequency of use.

The guarantee period starts from the date of original purchase. For this reason, we recommend that the sales receipt be retained as proof of purchase. Without this proof (which is checked by the responsible Sennheiser service partner) you will not be reimbursed for any repairs that are carried out.

Depending on our choice, guarantee service comprises, free of charge, the removal of material and manufacturing defects through repair or replacement of either individual parts or the entire device. Inappropriate usage (e.g. operating faults, mechanical damages, incorrect operating voltage), wear and tear, force majeure and defects which were known at the time of purchase are excluded from guarantee claims. The guarantee is void if the product is manipulated by non-authorized persons or repair stations.

In the case of a claim under the terms of this guarantee, send the device, including accessories and sales receipt, to the responsible service partner. To minimize the risk of transport damage, we recommend that the original packaging is used. Your legal rights against the seller, resulting from the contract of sale, are not affected by this guarantee.

The guarantee can be claimed in all countries outside the U.S. provided that no national law limits our terms of guarantee.

## CE Declaration of Conformity

CE 0682

This equipment is in compliance with the essential requirements and other relevant provisions of Directives 1999/5/EC, 89/336/EC or 73/23/EC. The declaration is available on the internet site at [www.sennheiser.com](http://www.sennheiser.com).

Before putting the device into operation, please observe the respective country-specific regulations!

## Batteries or rechargeable batteries



The supplied batteries or rechargeable batteries can be recycled. Please dispose of them as special waste or return them to your specialist dealer. In order to protect the environment, only dispose of exhausted batteries.

## WEEE Declaration



Your Sennheiser product was developed and manufactured with high-quality materials and components which can be recycled and/or reused. This symbol indicates that electrical and electronic equipment must be disposed of separately from normal waste at the end of its operational lifetime.

Please dispose of this product by bringing it to your local collection point or recycling centre for such equipment. This will help to protect the environment in which we all live.



Sennheiser electronic GmbH & Co. KG  
30900 Wedemark, Germany  
Phone +49 (5130) 600 0  
Fax +49 (5130) 600 300  
[www.sennheiser.com](http://www.sennheiser.com)